

5.0T
Lifting Capacity

2130MM
Full Travel

25S
Full-Rise Time

8 DIRECTIONS
Play Detector



OVERALL DIMENSION



HX50BWF.PD8

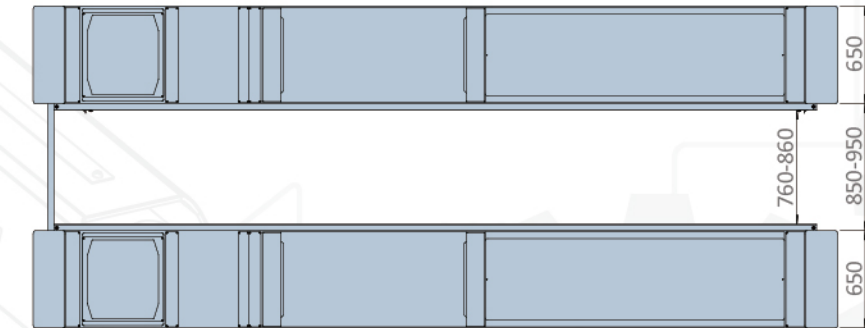
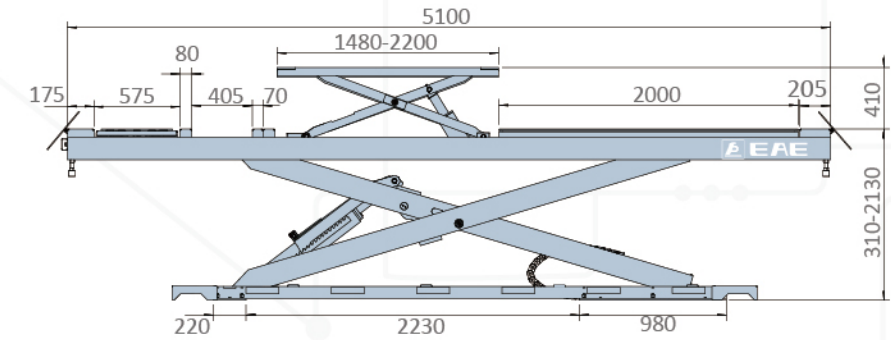

- S Flat platforms
- B Platforms with front recesses and rear slip plates
- BWF Platforms with front recesses, rear slip plates, and wheel free lifts

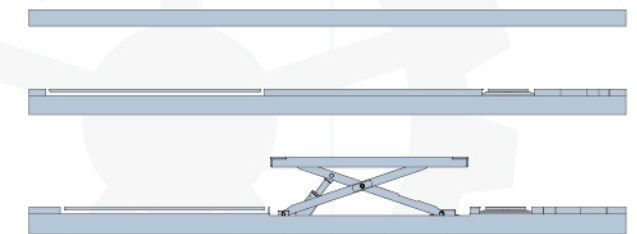

TECHNICAL DATA

MODEL NO.	HX50
Lifting capacity	5.0T
Max. lifting height	2130mm(1820mm above floor)
Min. height	310mm
Lifting time	Approx. 25S
Motor	3.5kWx2/3ph
Air supply	6-8bar
Platform width	650mm
Electricity supply	According To Customer Needs

* Machine shown with optional equipment. Actual product appearance may differ.



HX50

ALIGNMENT SCISSOR LIFT

- Maximum lifting height 1820mm above floor.
- 5100mm long flat runways for general service use.
- Infrared synchronization protection system.
- The most of vehicles can be lifted by the Wheel-free Lifting Platform, which loads up to 4.0T and extends up to 2200mm.
- Only 25 seconds for raising to shorten your service time.
- Flexible positions for turning plates. Accurate wheel-alignment is efficiently done using its pneumatic-controlled slip plates together with the radius turning plates.
- Four portable LED lamps attached magnetically by the platform to provide sufficient light under vehicles.
- Optional Play Detector, with its longitudinal and transversal movement being as much as 100 mm, is made as per the DIRECTIVE 2014/45/EU.



Low Voltage Control Unit

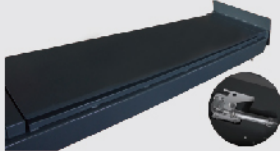

Pneumatic Rear Side Slip

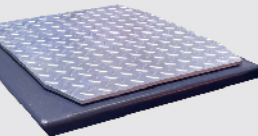

PD8 (Optional)



Infrared synchronization protection system



Pneumatic Release Mechanical Lock

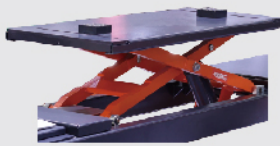

Wheel Free Lift